

WIDEPIX[®]_{2(1)x5} - MPX3

Datasheet

Model No.: W25xM3-Xxx180307

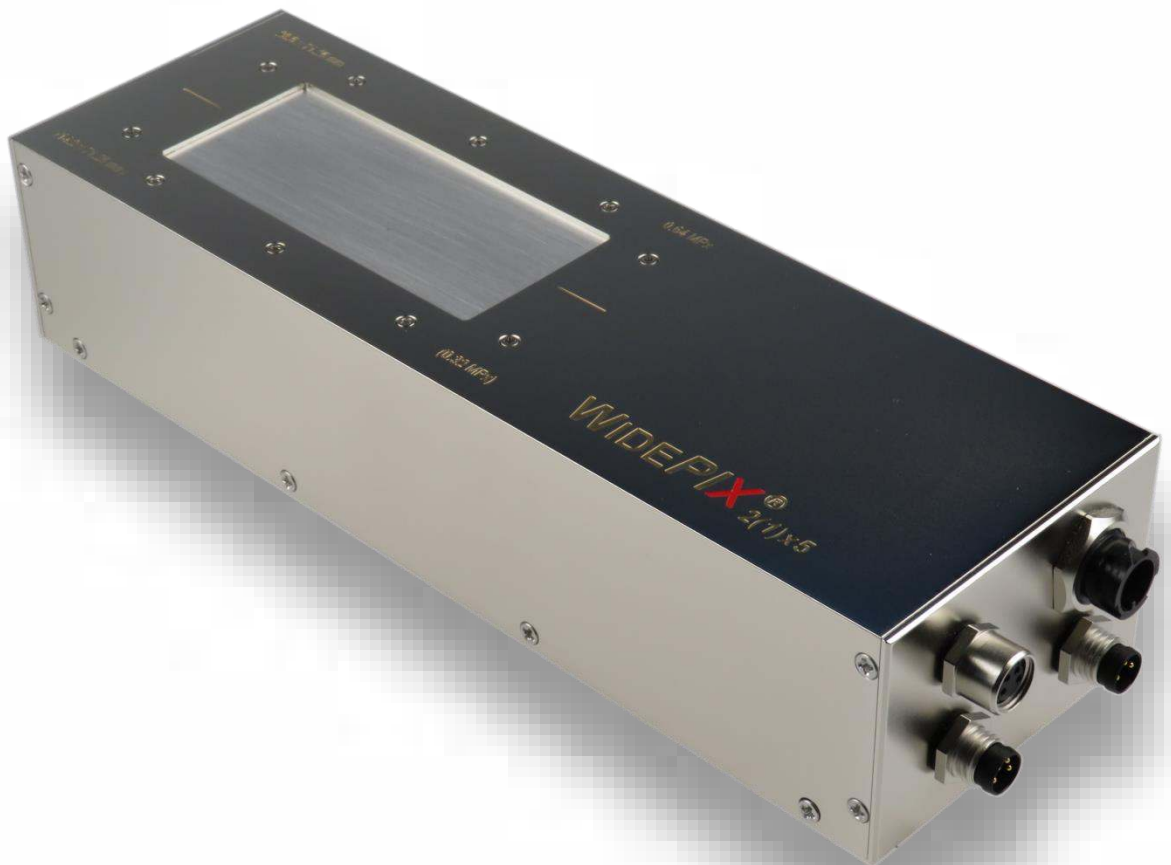

General features

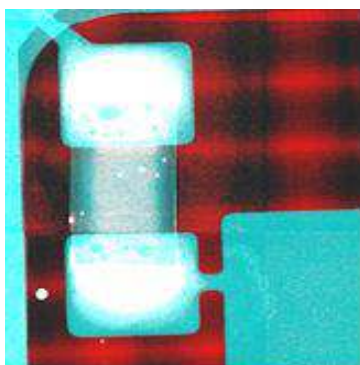
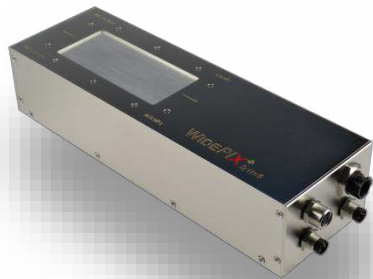

Illustration of multichannel “color” radiographs where different materials are identified and imaged in different colors

The large area imaging detector **WIDEPIX_{2(1)x5} - MPX3** with resolution of 512 (256) x 1280 pixels i.e. 0.64 (0.32) Mpixels is composed of Medipix3 hybrid detector electronics tiles. Each tile (256 x 256 pixels) is attached to an edgeless silicon or CdTe sensor. Therefore, the whole area of the **WIDEPIX_{2(1)x5} - MPX3** device is fully sensitive and there are no gaps between sensor tiles. Each pixel has two integrated 12-bit digital counters and two energy discrimination thresholds. The counters store number of registered particles, e.g. X-ray photons, with energy above the appropriate threshold. Both counters can be joined to a single 24-bit counter providing enhanced dynamic range. The particle counting principle eliminates any additional noise generated by the sensor or electronic readout. It allows acquiring X-ray images with very high contrast and wide dynamic range. Therefore, even low contrast structures such as plastic or soft tissue are easily detectable in X-ray images.

Both devices are suitable for CT scanners, which can take advantage of large sensitive area without any gaps. The **WIDEPIX_{1x5} - MPX3** variant moreover supports a hardware-based Time-Delayed-Integration mode for online (continuous) scanning applications.

The energy discrimination thresholds of Medipix3 technology allow spectral X-ray imaging. Different materials in an inspected sample could be then identified based on their spectral X-ray attenuation properties. Energy spectra could be measured typically from 5 keV upwards.

The Charge Summing Mode implemented in the pixel electronics provides hardware-based correction of signal cross talk between pixels. This further considerably improves the detector spectral response and therefore also quality of spectra measured in individual pixels.

The camera is connected to a computer via USB 2.0 cable. The readout time is 50 (25) ms per frame resulting in maximum frame rate of 20 (50) frames per second.

Main Features

- Readout chip type Medipix3
- Pixel size 55 x 55 μm
- Sensor resolution 512 (256) x 1280 pixels
- Dynamic range in one frame 12-bit / 24-bit¹
- Dark current none
- Interface USB 2.0 (Full-Speed)
- Maximum frame rate 20 (50) fps
- Dimensions 213 x 60 x 40 mm
- Weight 1800 g

¹ Depends on operation mode. Higher dynamic range can be achieved by summing multiple images.



Device parameters

Operating conditions

Symbol	Parameter	Min	Typ	Max	Units	Comment
T _A	Temperature Range	0	30	40	°C	
Φ	Humidity		55	60	%	Not condensing
	IP Code		IP50			

Family parameters

T_A = 25°C, V_{CC} = 24V

Symbol	Parameter	WidePIX 1x5 - MPX3	WidePIX 2x5 - MPX3	Units	Comment
V _{CC}	Supply Voltage	20/24/26		V	Min/Typ/Max
I _{CC}	Supply Current (V _{CC} = 24V)	340/680	800/1600	mA	Typ/Max
P	Power dissipation	9/18	16/36	W	Typ/Max
A	Sensor Area	71.5 x 14.1	71.1 x 28.2	mm	
	Detector Resolution	256 x 1280	512 x 1280	Pixels	
f	Frame Rate ¹	50	20	fps	
T _{READ}	Readout Time ²	20	50	ms	
m	Weight	1700	1800	g	

Modes of readout chip operation

Type	Mode	Bit depth	Description
Frame (reading all pixels)	SPM-1Ch	12/24 bit/frame	Single Pixel Mode using one counter: Every pixel works independently of its neighbours. One energy threshold (energy channel) is available. 1 output image: Number of events per pixel
	SPM-2Ch	12 bit/frame	Single Pixel Mode using both counters: Every pixel works independently of its neighbours. Two energy thresholds (energy channels) are available. 2 output images: Number of events per pixel
	CSM	12/24 bit/frame	Charge Summing Mode: The charge from 4 adjacent pixels is summed and is assigned to the pixel with the largest charge deposition. The event is counted only if the sum of singals exceeds the energy threshold. 1 output image: Number of events per pixel

All modes can be operated at two ranges: Broad / Narrow / Super Narrow³

¹ Operating parameters: Shutter time=1ms, Mode = CSM or SPM-1Ch 12bit resolution.

² During Readout time (or Dead time), no charge is collected from the sensor.

³ Except CSM mode Silicon sensor.



Energy range and resolution

Typical values for 300 μm Silicon sensor, $T_A = 20^\circ\text{C}$.

Range	Mode	Min Energy [keV]	Max Energy [keV]	Resolution* @Cu-K α (cca 8 keV)	Resolution* @Zr-K α (cca 15 keV)	Resolution* @Pb-K α (cca 75 keV)
Super Narrow	SPM	2.5 - 4.0	100 - 110	0.7 – 1.5		3.5 – 7.0
Narrow	SPM	2.5 – 4.0	160 - 180	0.8 – 1.3	-	3.0 - 3.8
	CSM	6.0	-	1.5	1.5	12.0
Broad	SPM	5.0 – 6.5	260 - 290	1.6 – 2.0	-	3.3 - 4.0
	CSM	8.0	-	-	2.3	5.8

Typical values for 1000 μm CdTe sensor, $T_A = 20^\circ\text{C}$

Range	Mode	Min Energy [keV]	Max Energy [keV]	Resolution* @Cu-K α (cca 8 keV)	Resolution* @Zr-K α (cca 15 keV)	Resolution* @Pb-K α (cca 75 keV)
Super Narrow	SPM	5.0 - 10				
	CSM	10 – 20				
Narrow	SPM	5.0 - 10				
	CSM	10 – 20				
Broad	SPM	5.0 - 10				
	CSM	10 – 20				

* resolution in Sigma of gaussian fit.

Sensor parameters

Sensor material

Symbol	Parameter	Si		CdTe	Units	Comment
	Thickness	300	1000	1000	μm	
V_{bias}	Bias Voltage	200	500	-450	V	Max
	Typical detectable energy range for X-rays*	up to 60		up to 600	keV	See chart below
	Pixel size	55 x 55**			μm^2	

* to get true detector response, detectable energy and quantum efficiency of sensor chip has to be combined with energy range of readout chip (see chapter “Energy range and resolution”)

** Pixels on tile borders are 2.5 times larger in one direction. The corner tile pixels are 2.5 times larger in both directions.



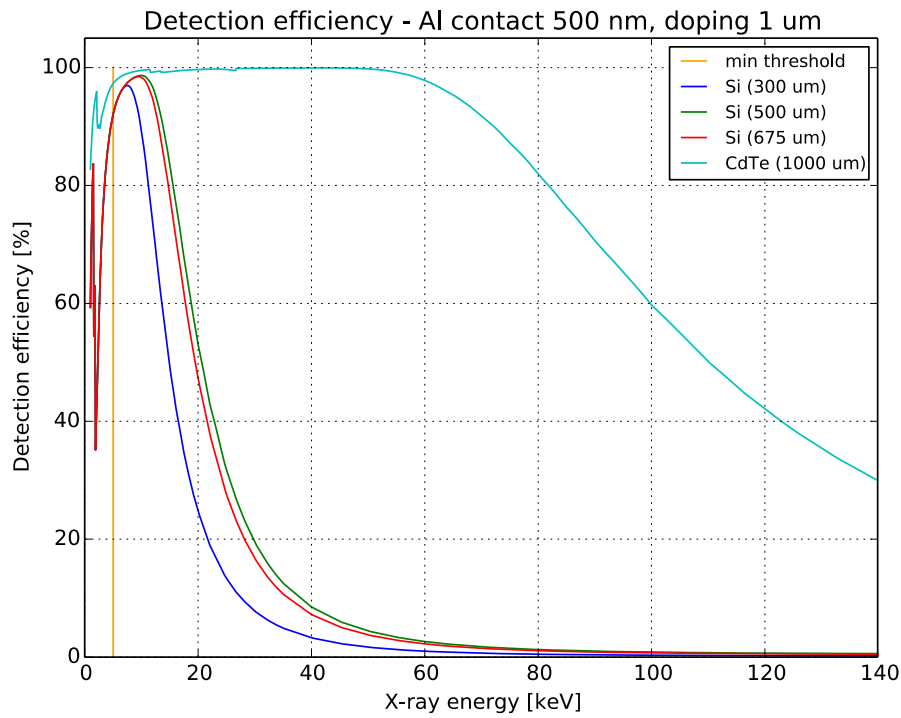

Device description



USB connector

USB type A, Standard USB 2.0 Full-Speed, in IP68 protection.

+24VDC connector

Main power supply (via standard M8 connector with 3 female contacts) Connect after plugging USB connector.

Synchronization interface

Two 4-pin M8 connectors (female for outputs and male for input) serve as synchronization interface, allowing to synchronize **WIDEPIX_{2(1)x5} - MPX3** detector with external processes. Four signals are available:



- **Ready in** – measurement is not possible, when signal at logical zero
- **Trigger in** – logical zero starts shutter (measurement)
- **Ready out** – logical one if device is ready to for new shutter
- **Trigger out** – mirrors shutter (logical zero when shutter is active)

All signals are TTL compatible and 5V tolerant. For detailed description see **Synchronization Guide**.

Sync. Outputs (M8-4Female)		Sync. Inputs (M8-4Male)	
Pin	Signal	Pin	Signal
1	Gnd	1	Gnd
2	Ready Out	2	Trigger In
3	Trigger Out	3	Ready In
4	Reserved	4	Reserved

Water cooling interface

It is mandatory to cool down detector when in operation. **WIDEPiX_{2(1)x5} - MPX3** uses water connectors that allow for quick disconnection/reconnection. Mating connector is included as standard accessories and has to be attached to 4x6mm plastic hose.



Mechanical dimensions

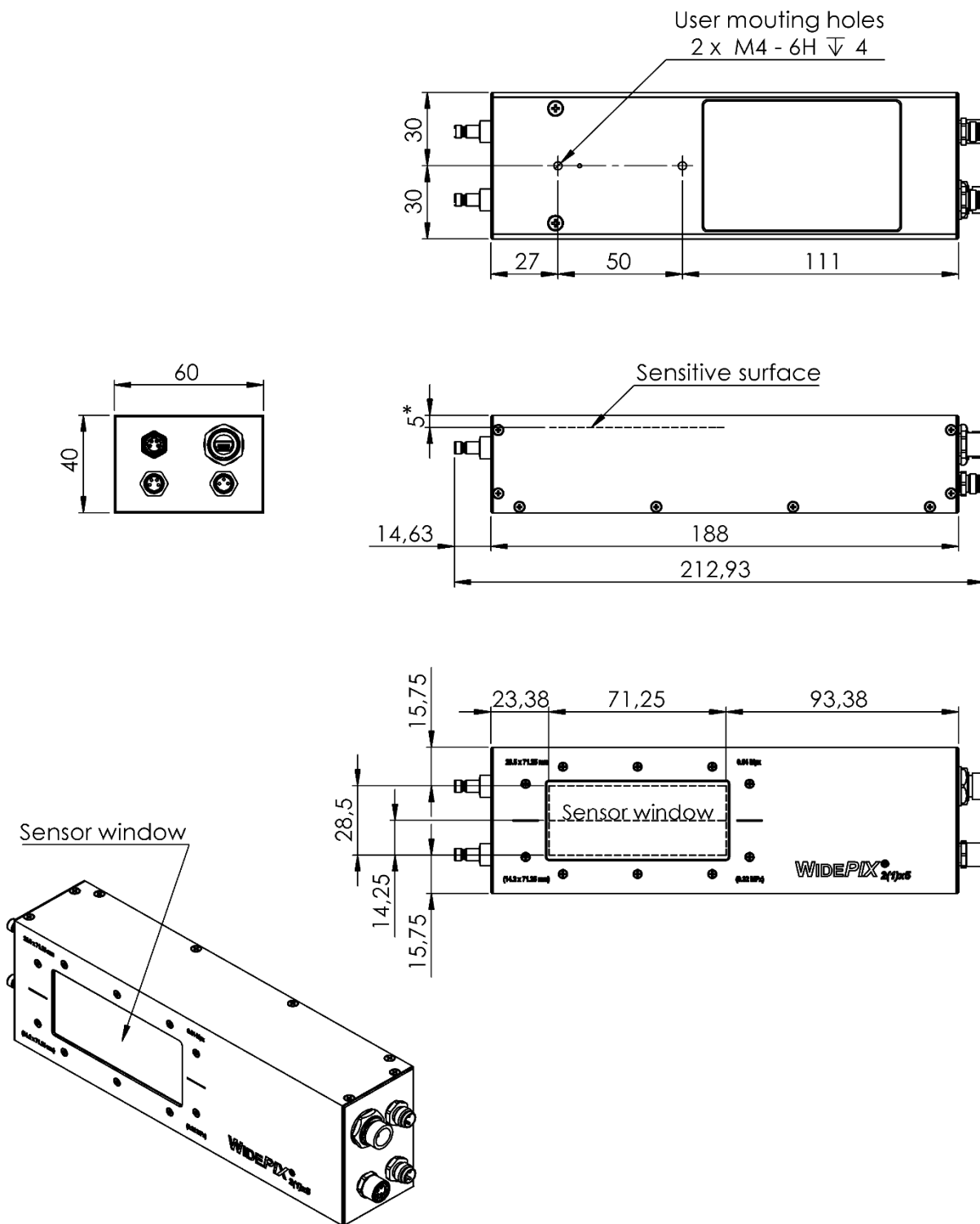

All dimensions are in mm.

* Sensitive surface distance from top of the box may vary depending on actual sensor thickness.



Sensitive area

Sensitive area for **WIDEPIX**_{1x5} - MPX3

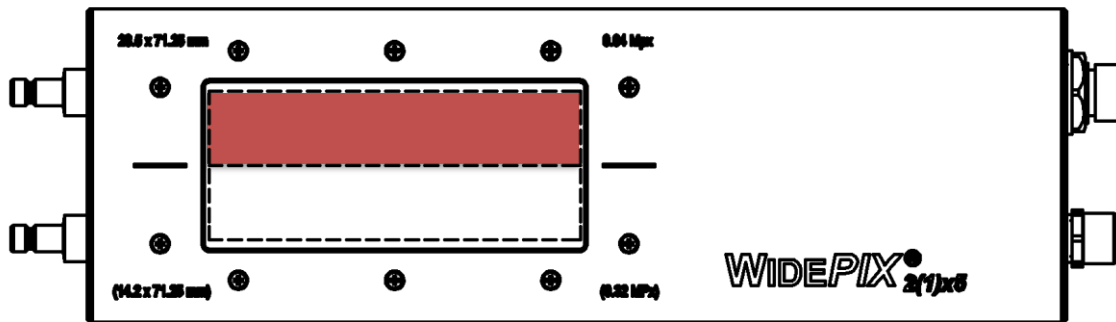

Sensitive area for **WIDEPIX**_{2x5} - MPX3

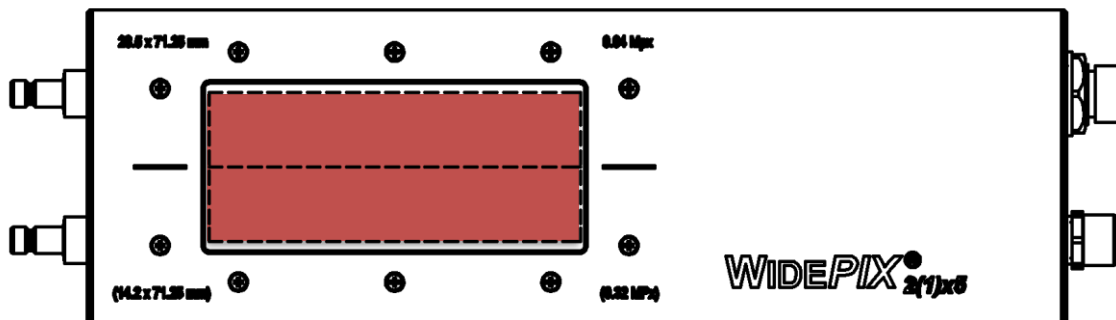

Product/Model number codes

- W251M3-XE3170307 – 1 row, Si edgeless sensor, thickness 300 μm
- W251M3-XEA170307 – 1 row, Si edgeless sensor, thickness 1000 μm
- W251M3-XCA170307 – 1 row, CdTe sensor, thickness 1000 μm
- W252M3-XE3170307 – 2 rows, Si edgeless sensor, thickness 300 μm
- W252M3-XEA170307 – 2 rows, Si edgeless sensor, thickness 1000 μm
- W252M3-XCA170307 – 2 rows, CdTe sensor, thickness 1000 μm

Model Number Codes

Example:

W25 2M3 - X C A 170307

Device name:

W25 – WidePIX 1(2)x5

Device modification:

1M3 – 1x5 Medipix3 chips

2M3 – 2x5 Medipix3 chips

Sensor type:

E – Edgeless silicon

C – CdTe

Sensor thickness:

3 – 300 µm

5 – 500 µm

A – 1000 µm

Device version date:

YY MM DD

Release history

Date	Changes
14/06/18	Preliminary version
15/10/18	



Warning

Do not touch sensor surface!

Instructions for safe use

To avoid malfunction or damage to your **WIDEPIX_{2(1)x5}-MPX3** please obey the following:

- Do not expose to water or moisture, **WIDEPIX_{2(1)x5}-MPX3** is dust protected only.
- Do not open **WIDEPIX_{2(1)x5}-MPX3** case. Detector wire-bonding connections may be irreversibly damaged.
- Do not operate detector when not properly water cooled. Otherwise detector temperature may rise above the specified range.

Copyright

ADVACAM s.r.o.

U Pergamenky 1145/12

170 00 Praha

Czech Republic

Tel: +420 603 444 112

Email:

info@advacam.com

www.advacam.com

